

يوروتكش م ح  
EUROTECH FZCO



# Eurotech Enclosures

## COMPACT SERIES



ENERGY



INDUSTRY



RESIDENTIAL



INFRASTRUCTURE



EHS Award  
Silver Medal 2007

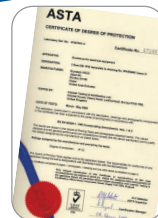

ASTA & KEMA  
Certified

# EUROTECH ENCLOSURES - COMPACT SERIES



## Compact Enclosures

- ⤴ This set of enclosures are compact in design with maximum utilization of space.
- ⤴ Manufactured out of electrogalvanized steel sheet, the welded mono block body with folding at the front gives good rigidity.
- ⤴ Electrogalvanized steel sheet combined with zinc phosphating and electrostatic powder coating with polyester powder (RAL 7032-texture) gives excellent resistance to corrosion in the hot, humid & salt laden atmosphere.
- ⤴ 120 degree openable, concealed hinges are easily removable for performing cutout operations on door.
- ⤴ Neoprene gasketed gland plates (top gland plate-optional) can be fixed inside or out side the enclosure.
- ⤴ Standard double bit key operated locks can be substituted with optional wing knob type (lockable & non lockable) locks.
- ⤴ Wall mounting provision for direct fixing or with optional wall mounting brackets.
- ⤴ Easy fixing of mounting plates with studs for optimum use of space.
- ⤴ Welded earth studs for door/body earthing.
- ⤴ ASTA certified for degree of protection IP 54 & 55.
- ⤴ KEMA certified for degree of protection IP65.



HINGES & MOUNTING PLATE



EARTHING BETWEEN  
BODY & DOOR



WALL MOUNTING  
BRACKET



STANDARD LOCK

FRONT VIEW (WITHOUT DOOR)

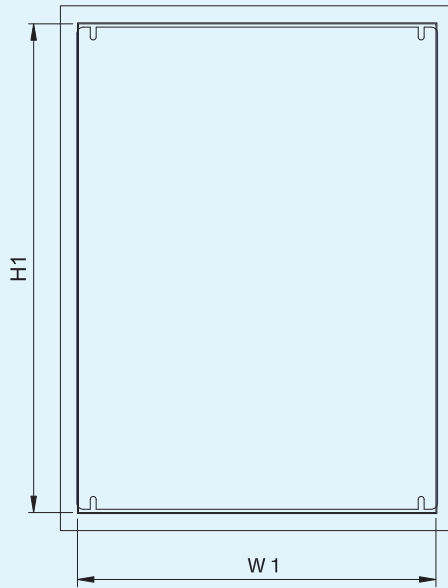

FRONT VIEW

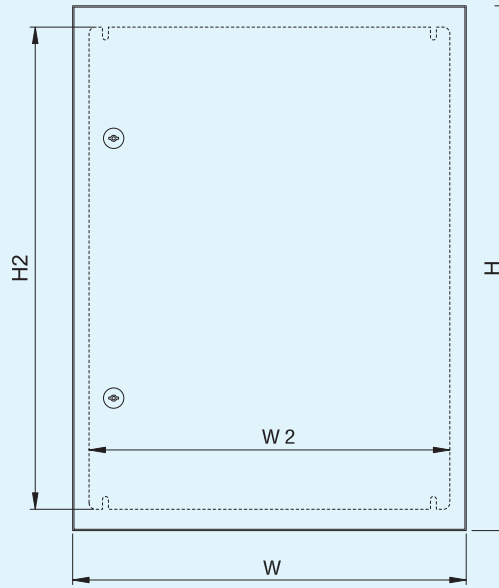

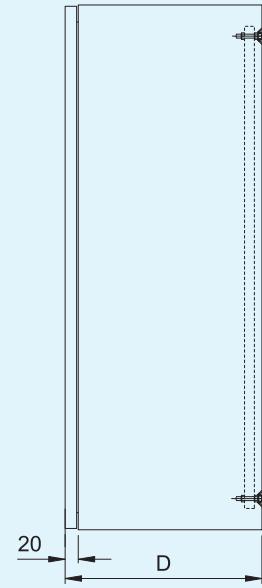

SIDE VIEW

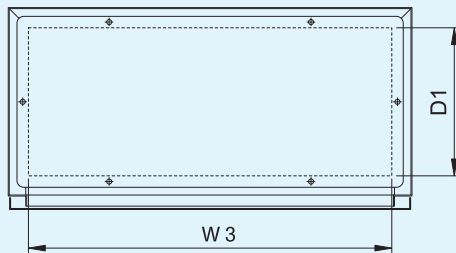

BOTTOM GLAND PLATE



LOCK TYPES

Standard	Double Bit	
Optional	Wing Knob	
Optional	Lockable Wing Knob	

**ORDERING REFERENCES**

S. No.	EUROTECH REFERENCES	SIZE: H x W x D	THICK	NO. OF LOCK	H1	W1	W3	D1	MOUNTING PLATE		
									H2	W2	THICK
1	ETC 32/150	300 x 200 x 150	1.5	1	245	145	140	70	235	150	2
2	ETC 43/150	400 x 300 x 150	1.5	1	345	245	240	70	335	250	2
3	ETC 64/150	600 x 400 x 150	1.5	2	545	345	340	70	535	350	2
4	ETC 66/150	600 x 600 x 150	1.5	2	545	545	540	70	535	550	2
5	ETC 86/150	800 x 600 x 150	1.5	2	745	545	540	70	735	550	2
6	ETC 106/150	1000 x 600 x 150	1.5	2	945	545	540	70	935	550	2
7	ETC 126/150	1200 x 600 x 150	1.5	2	1145	545	540	70	1135	550	2
8	ETC 146/150	1400 x 600 x 150	1.5	2	1345	545	540	70	1335	550	2
9	ETC 32/200	300 x 200 x 200	1.5	1	245	145	140	120	235	150	2
10	ETC 43/200	400 x 300 x 200	1.5	1	345	245	240	120	335	250	2
11	ETC 64/200	600 x 400 x 200	1.5	2	545	345	340	120	535	350	2
12	ETC 66/200	600 x 600 x 200	1.5	2	545	545	540	120	535	550	2
13	ETC 86/200	800 x 600 x 200	1.5	2	745	545	540	120	735	550	2
14	ETC 106/200	1000 x 600 x 200	1.5	2	945	545	540	120	935	550	2
15	ETC 126/200	1200 x 600 x 200	1.5	2	1145	545	540	120	1135	550	2
16	ETC 146/200	1400 x 600 x 200	1.5	2	1345	545	540	120	1335	550	2
17	ETC 66/300	600 x 600 x 300	1.5	2	545	545	540	220	535	550	2
18	ETC 86/300	800 x 600 x 300	1.5	2	745	545	540	220	735	550	2
19	ETC 106/300	1000 x 600 x 300	1.5	2	945	545	540	220	935	550	2
20	ETC 88/300	800 x 800 x 300	1.5	2	745	745	740	220	735	750	2

ALL DIMENSIONS ARE IN MM



**EUROTECH** has superior level of engineering competence in manufacturing metal enclosures for Low and Medium voltage Switchgear. It can very quickly respond to the highly demanding market.

With well qualified and experienced engineers and equipped with latest tailor-made Design and Engineering software and most modern state of the art manufacturing machinery like CNC Punch Presses, CNC Pressbrakes, welding machines **EUROTECH** can offer products which are consistent in quality giving full reliability to the customer.

**EUROTECH** Products are made of Electro Galvanised Steel sheets, Aluminium and Stainless steel.

To withstand the highly corrosive, hot, humid and salt laden atmospheric conditions, **EUROTECH** plant is equipped with conveyerised, 7 stage spray zinc phosphating pretreatment process combined with automatic electrostatic polyester powder coating ensuring the durability of its products.

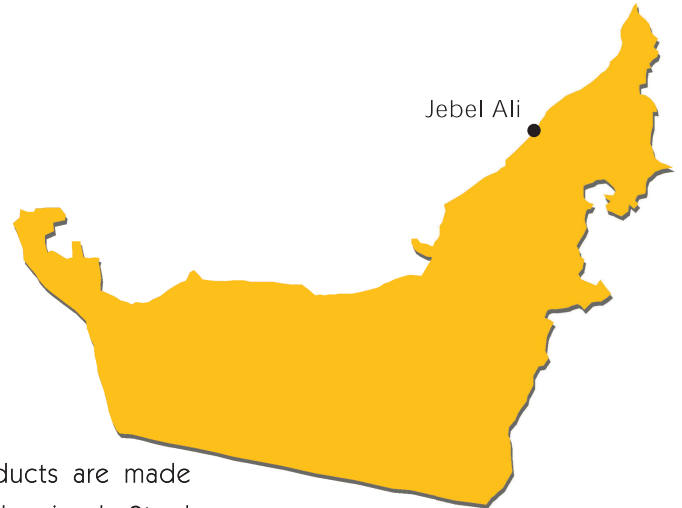

In a nutshell, Eurotech offers value for money to the customer in UAE which is vouched by prestigious clients.



## **EUROTECH FZCO**

Manufacturing of Metal Enclosures &  
Trading in Electrical Switchboards

P.O. Box: 61196, Jebel Ali, Dubai, United Arab Emirates  
Tel: 00971 4 8830333, Fax: 00971 4 8830339, E-mail: [general@eurotech-fzco.ae](mailto:general@eurotech-fzco.ae)